

# TESTE PORTACOLTELLI HW PER PIALLARE "CENTROLOCK"

PLANING HW INSERT CUTTERHEAD  
"CENTROLOCK" SYSTEM

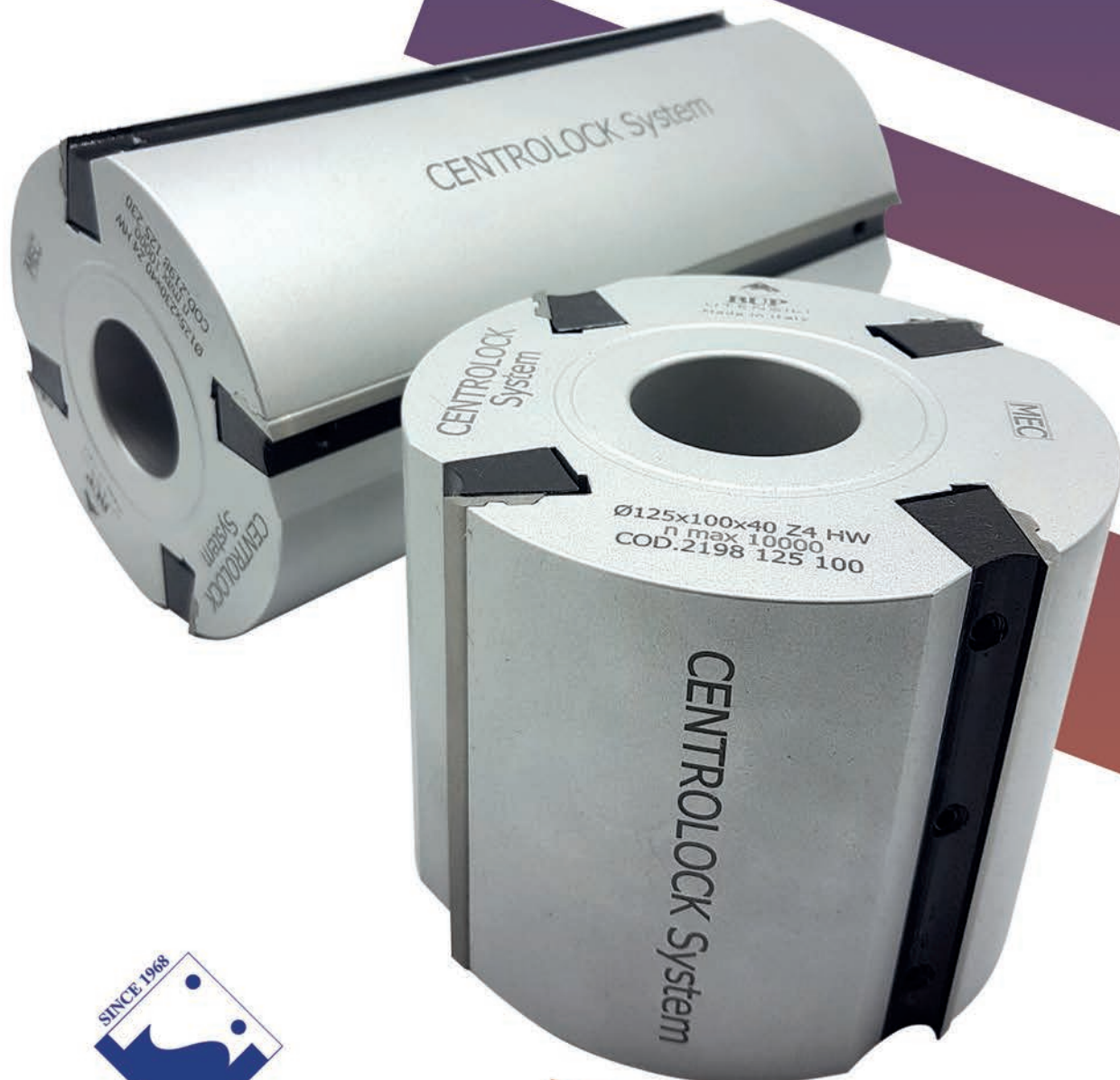

**BUP**<sup>®</sup>

U T E N S I L I

CENTROLOCK System

# TESTE PORTACOLTELLI HW PER PIALLARE "CENTROLOCK"

## PLANING HW INSERT CUTTERHEAD "CENTROLOCK" SYSTEM

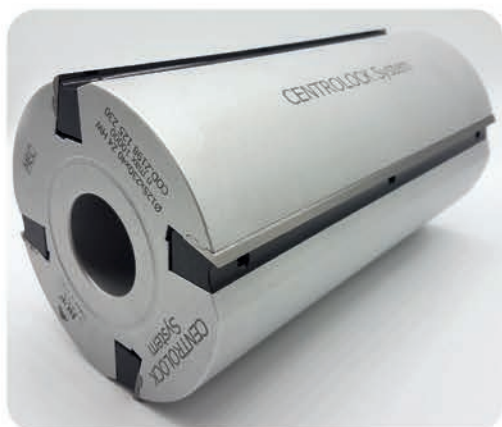

**HW** **MEC** Avanzamento meccanico  
Mechanical feed

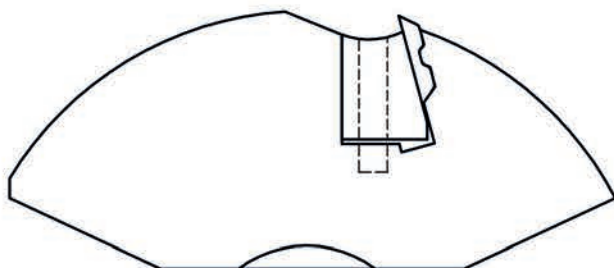

**APPLICAZIONE/APPLICATION:**  
Piallatura su legni teneri e duri.  
Planing on hard and soft solid wood.

**MACCHINA/MACHINE:**  
Macchine scormiatrici. / Four sides moulders.

**INFORMAZIONI TECNICHE/TECHNICAL INFORMATION:**  
Teste pialla con corpo in lega leggera ERGAL, equipaggiata con coltelli HW sistema Centrolock. Permette una sostituzione rapida e precisa dei coltelli grazie al suo auto bloccaggio centrifugo, come ricambi sono disponibili anche coltelli in acciaio HSS per lavorazione di legno teneri.

Insert planer cutterheads manufactured with ERGAL light alloy body, equipped with Centrolock HW inserts. The system allows a quick and precise knife replacement thanks to its self-locking centrifugal inserts. As spare parts are also available HSS inserts for soft wood processing.



Codice Code	D D	B B	d max d max	Z Z	RPM max. RPM max.
2198 100 080	100	80	35	4	13000
2198 100 100	100	100	35	4	13000
2198 100 130	100	130	35	4	13000
2198 125 080	125	80	40	4	10000
2198 125 100	125	100	40	4	10000
2198 125 130	125	130	40	4	10000
2198 125 150	125	150	40	4	10000
2198 125 160	125	160	40	4	10000
2198 125 210	125	210	40	4	10000
2198 125 230	125	230	40	4	10000
2198 125 240	125	240	40	4	10000
2198 140 080	140	80	40	6	9000
2198 140 100	140	100	40	6	9000
2198 140 130	140	130	40	6	9000
2198 140 150	140	150	40	6	9000
2198 140 160	140	160	40	6	9000
2198 140 210	140	210	40	6	9000
2198 140 230	140	230	40	6	9000
2198 140 240	140	240	40	6	9000

# TESTE PORTACOLTELLI HW PER PIALLARE "CENTROLOCK" PLANING HW INSERT CUTTERHEAD "CENTROLOCK" SYSTEM

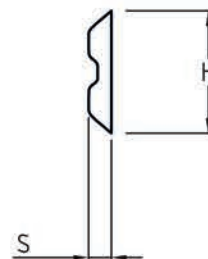
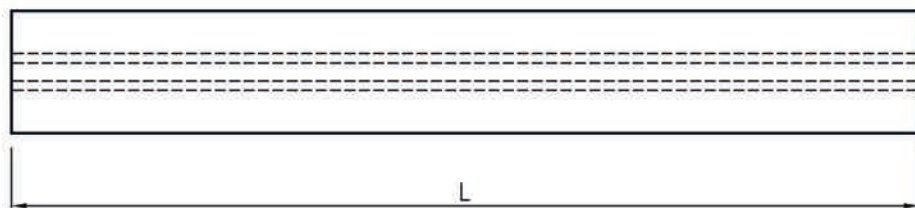

## 8016 - RICAMBI /Spare Parts HW

Codice Code	L L	H H	S S
8016 080 000	80	16	3
8016 100 000	100	16	3
8016 130 000	130	16	3
8016 150 000	150	16	3
8016 160 000	160	16	3
8016 170 000	170	16	3
8016 180 000	180	16	3
8016 190 000	190	16	3
8016 210 000	210	16	3
8016 220 000	220	16	3
8016 230 000	230	16	3
8016 240 000	240	16	3
8016 260 000	260	16	3
8016 270 000	270	16	3
8016 300 000	300	16	3
8016 310 000	310	16	3
8016 460 000	460	16	3
8016 650 000	650	16	3

## 8017 - RICAMBI /Spare Parts HSS

Codice Code	L L	H H	S S
8017 080 000	80	16	3
8017 100 000	100	16	3
8017 130 000	130	16	3
8017 150 000	150	16	3
8017 160 000	160	16	3
8017 170 000	170	16	3
8017 180 000	180	16	3
8017 190 000	190	16	3
8017 210 000	210	16	3
8017 220 000	220	16	3
8017 230 000	230	16	3
8017 240 000	240	16	3
8017 260 000	260	16	3
8017 270 000	270	16	3
8017 300 000	300	16	3
8017 310 000	310	16	3
8017 460 000	460	16	3
8017 650 000	650	16	3
8017 710 000	710	16	3
8017 810 000	810	16	3
8017 1050 000	1050	16	3

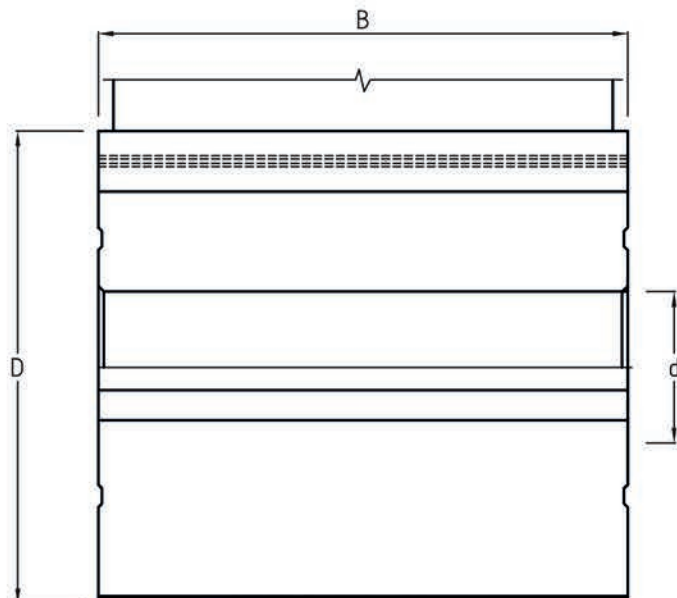
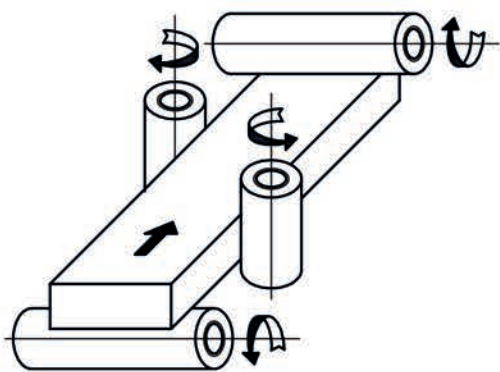



CENTROLOCK System



**BUP**<sup>®</sup>  
U T E N S I L I

**BUP Utensili**

61122 Pesaro • Italy • Via Liguria, 15  
Tel. (39)0721\_453454 (4 linee r.a.)  
Fax (39)0721\_455448  
[www.buputensili.it](http://www.buputensili.it) • [info@buputensili.it](mailto:info@buputensili.it)